

Parts Breakdown

Model RS-CN-0006-PSS 46657

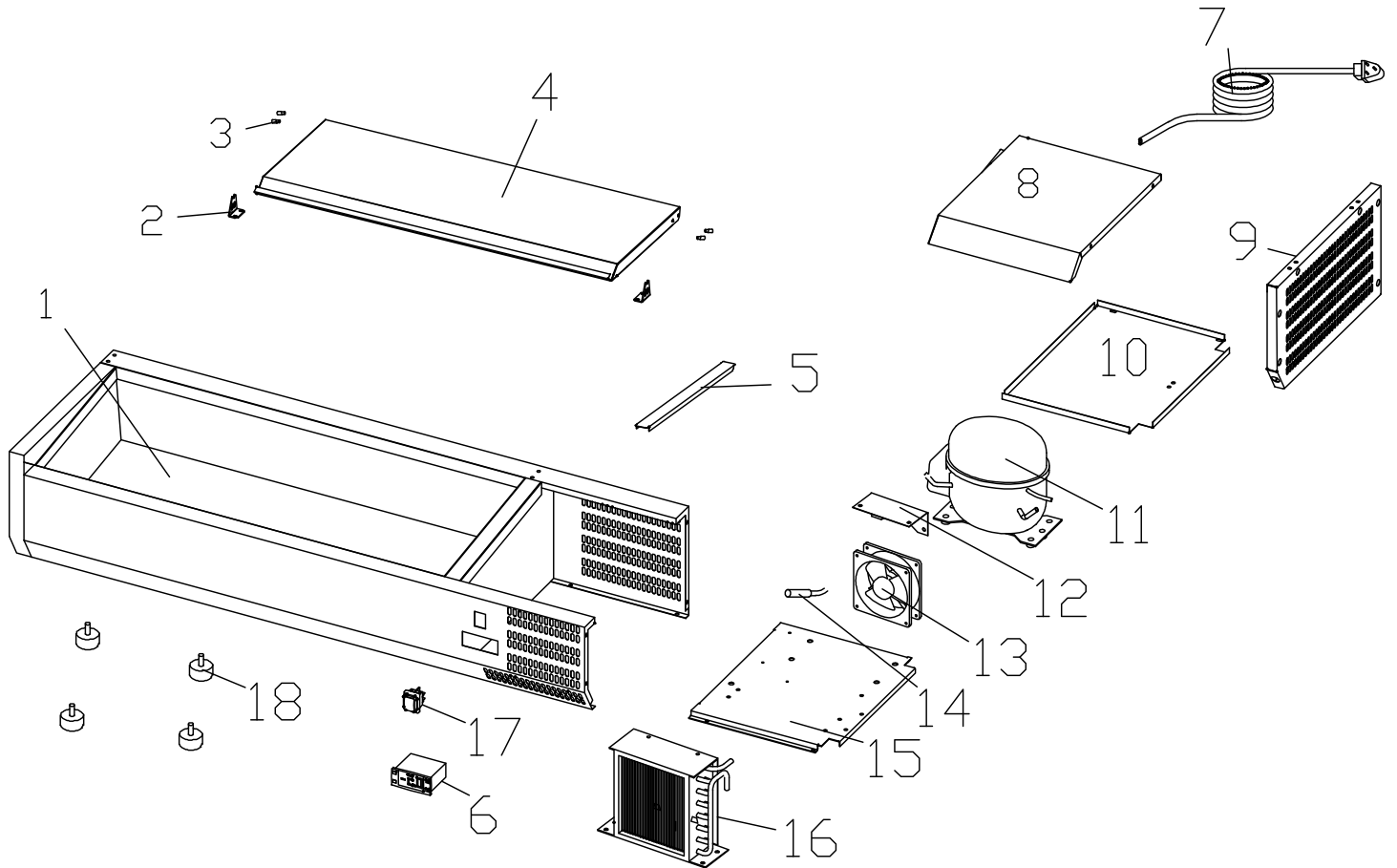

Parts Breakdown

Model RS-CN-0006-PSS 46657

Item No.	Description	Position	Item No.	Description	Position	Item No.	Description	Position
AD831	Body for 46657	1	AD819	Power Cord for 46657	7	AD826	Sensor for 46657	14
AD813	Cover Hinge Left for 46657	2	AD820	Stainless Steel Pan Cover for 46657	8	AD827	Unit Board for 46657	15
AD814	Cover Hinge Right for 46657	2	AD821	Side Cover for 46657	9	AD828	Condenser for 46657	16
AD815	Cover Hinge Axis for 46657	3	AD822	Unit Plate for 46657	10	AD829	Main Switch for 46657	17
AD832	Stainless Steel Lid for 46657	4	AD823	Compressor for 46657	11	AD830	Adjustable Feet for 46657	18
AD833	Pan Support for 46657	5	AD824	Fan Connection Board for 46657	12			
AD818	Thermostat for 46657	6	AD825	Condenser Fan for 46657	13			